

DATASHEET - DIMENSIONS

HYDRAULIC CYLINDERS STANDARD 50/30-xxx

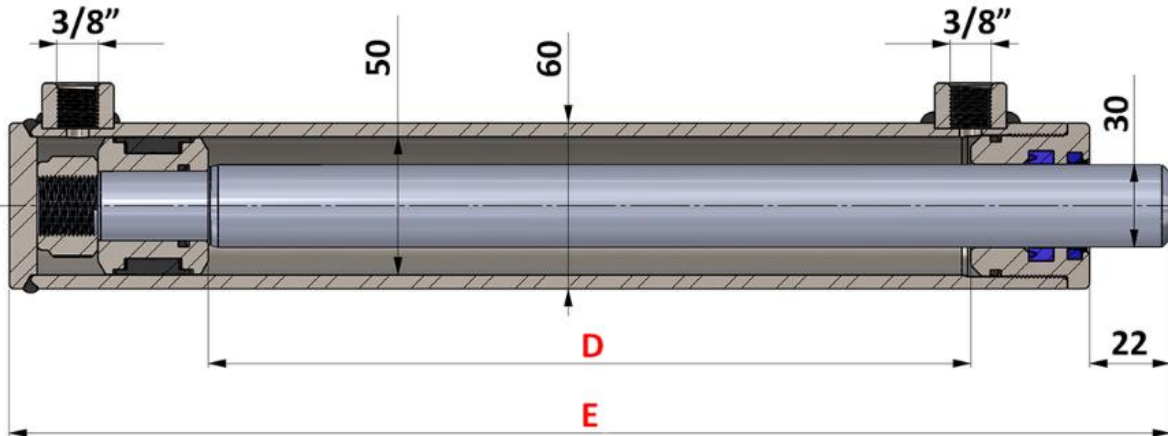

	STANDARD	E	D (stroke)
Code	50/30-xxx	[mm]	
10294	50/30-100	240	100
10295	50/30-150	290	150
10173	50/30-200	340	200
10512	50/30-250	390	250
10296	50/30-300	440	300
10513	50/30-350	490	350
10174	50/30-400	540	400
10297	50/30-450	590	450
10175	50/30-500	640	500
10514	50/30-550	690	550
10298	50/30-600	740	600
10515	50/30-700	840	700
10176	50/30-800	940	800
10177	50/30-900	1040	900
10178	50/30-1000	1140	1000
12245	50/30-1100	1240	1100
12246	50/30-1200	1340	1200
12247	50/30-1300	1440	1300
12248	50/30-1400	1540	1400
12249	50/30-1500	1640	1500
14831	50/30-1750	1890	1750
14834	50/30-2000	2140	2000